

# BUBLIING Stwin

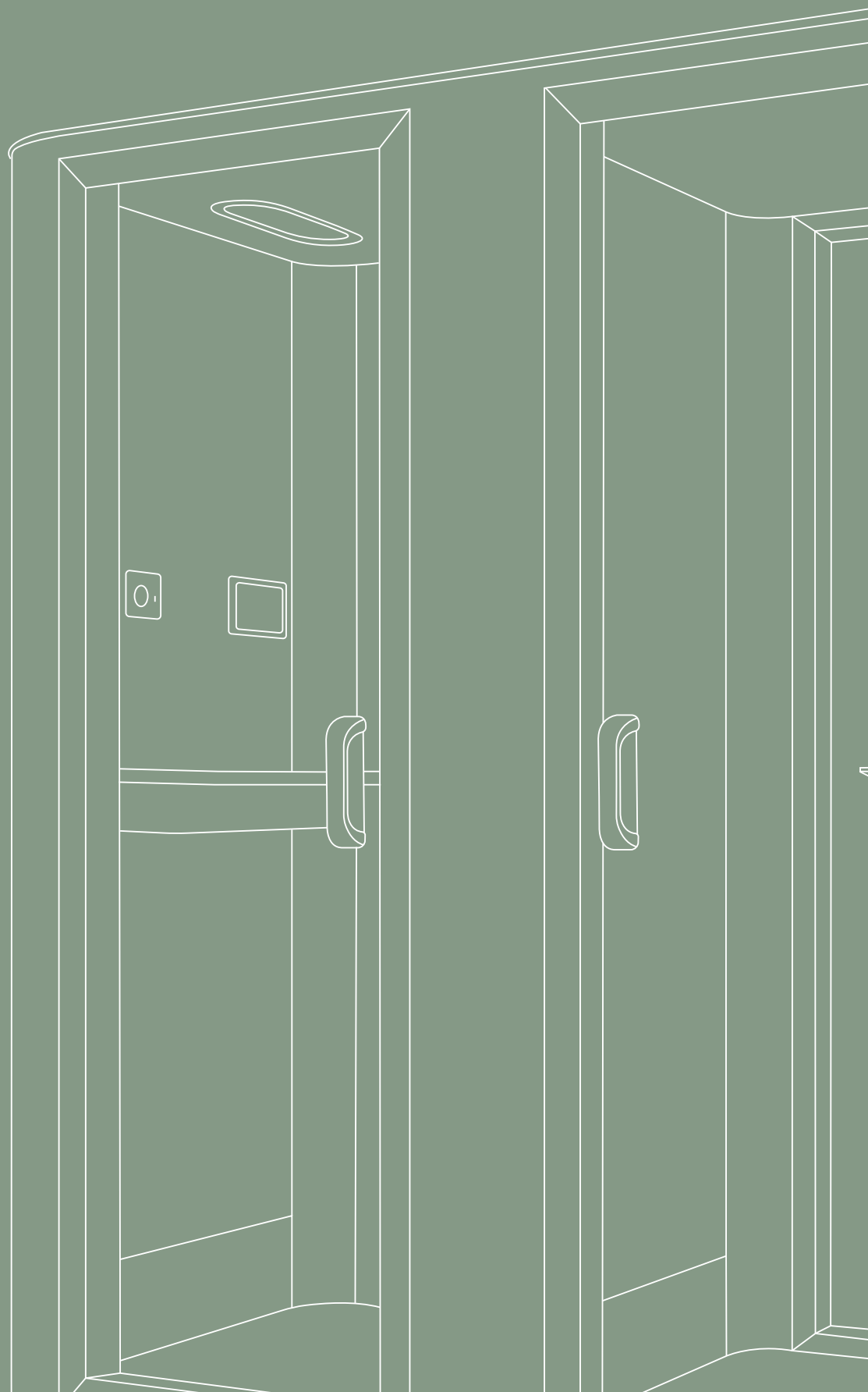



TECHINICAL SPECIFICATIONS





## Double the privacy, the same efficiency.

It combines two BUBLINGS, allowing two people to use it simultaneously and individually, carrying out tasks without compromising privacy while optimizing space.

-  A twice space for 1 person
-  Class A soundproofing
-  Guaranteed privacy and comfort
-  Automatic ventilation and lighting

## BUBLING Stwin | TECHNICAL SPECIFICATIONS

### GENERAL DESCRIPTION

<b>Dimensions</b>	<p>Exterior: 2006x1006x2245 mm / 78,98x39,61x88,39 in</p> <p>Optional with wheels: Additional 52 mm / 2,05 in</p> <p>With Bubling Fresh Air: Additional 50 mm / 1,97 in</p> <p>Interior: 778x974x2060 mm / 30,63x38,35x81,10 in</p> <p>Entrance height: 86 mm / 3,39 in ; With casters: 138 mm / 5,43 in</p> <p>The door: 2108x689 mm / 82,99x27,13 in</p>
<b>Standard weight</b>	590 kg / 1300 lb
<b>Acoustic</b>	<p><b>Class A   DB,A &gt;30 dB</b></p> <p>Guaranteed speech level reduction according to the ISO 23351-1 testing method, with one of the best ratings in the industry.</p>
<b>Sound production</b>	<p>Sound impact produced by the ventilation system.</p> <p><b>Interior:</b> 36 dB at head height.</p> <p><b>Exterior:</b> 25 dB at a distance of 1 meter.</p> <p>Test conducted according to ISO 11201:2010.</p>
<b>Fan airflow</b>	<p><b>Airflow:</b> 560,8 m<sup>3</sup>/h (4 fans)</p> <p>The air is renewed, on average, every 5,6 minutes.</p> <p>The airflow can be manually adjusted.</p> <p>In standby mode, the system activates for 10 minutes per hour.</p>
<b>Lighting</b>	<p><b>Ceiling light:</b> LED lighting with a temperature of 3500 K - 4000 K, providing up to 500 lux on the desk.</p> <p><b>Facial light:</b> LED lighting with a temperature of 3500 K - 4000 K, providing up to 500 lux on the user's face.</p> <p>The lighting is automatic and can be manually adjusted.</p>
<b>Occupancy indicators</b>	LED sensor technology with red or green light indicator.
<b>Mobility</b>	<p>High-resistance adjusters accessible from inside the cabin.</p> <p>The BUBLING is prepared to accommodate casters (optional).</p> <p>The adjusters must be lifted to move the cabin and retracted when in the desired position.</p>

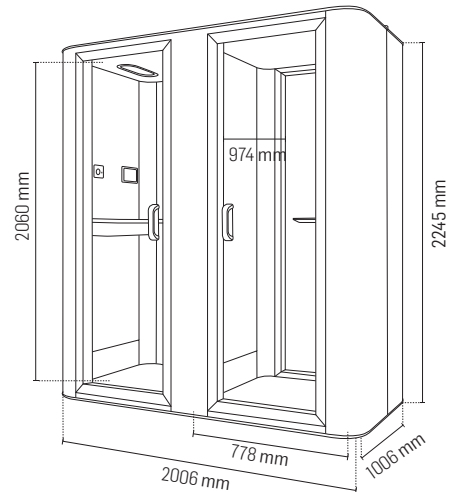

### MATERIALS

<b>Exterior</b>	<p><b>Exterior panels:</b> Made of thermocoated steel, replaceable in 10 available colors.</p> <p><b>Frame and door:</b> Made of aluminum coated in matte black RAL 9005, with an invisible pivot hinge.</p> <p><b>Handle:</b> Made of textured black polymer.</p> <p><b>Glass:</b> Clear acoustic glass, 8 mm / 0.31 in.</p>
<b>Interior</b>	<p><b>Structure:</b> Metal frame, wood, and recycled acoustic foam.</p> <p><b>Upholstery:</b> 100% polyester fabric available in 12 colors.</p> <p><b>Flooring:</b> 100% polyamide carpet available in 4 colors.</p> <p><b>Table:</b> Top and lower box made of birch plywood covered with white, fingerprint-resistant black laminate, or wood imitation laminate.</p>
<b>Standard furniture</b>	<p><b>Table dimensions:</b> 730x350x1050 mm / 28.74x13.78x41.34 in</p> <p><b>Table height:</b> 1050 mm / 41.34 in</p> <p>Maximum load for the table is 50kg / 110.23 lbs</p> <p><b>Clothes hanger:</b> coated in textured black RAL 9005.</p>
<b>Furniture options</b>	<p><b>Backrest:</b> 570x145x760 mm / 22.44x5.71x29.92 in</p> <p><b>High stool:</b> 400x400x580-780 mm / 15.75x15.75x22.83-30.71 in</p> <p>These optional items are upholstered in 100% polyester fabric, available in 12 colors.</p> <p>Maximum load for the seat is 135 kg / 297.12 lbs.</p>

With backrest:

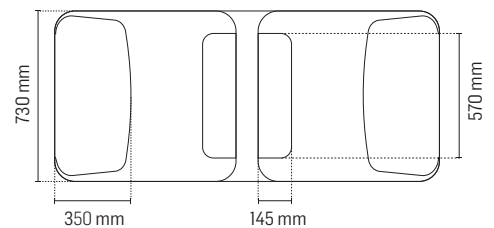

With High stool:

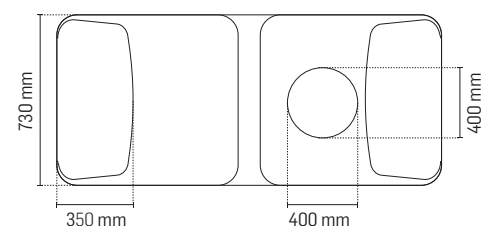

## BUBLING Stwin | TECHNICAL SPECIFICATIONS

### SAFETY

---

<b>Fire protection</b>	All coating materials, upholstery, and acoustic materials used in our products are tested and classified according to national or international standards.  Fabrics: EN 13501-1 Adhered Class B, s1, d0 Foams: ISO 3795 Carpet: EN 13501-1 CfL – s1 Wood: EN 13986, Class D-s2, d0
<b>Earthquake resistance</b>	The BUBLING can be supplied with a system that allows fixation to the floor, available for seismic regions.

### ENERGY

---

<b>Electrical equipment</b>	In each booth: 1x Schuko socket - 230 V 1x USB-C port Optional: USB-A port.
<b>Standard consumption</b>	60 W
<b>Standby consumption</b>	0,98 W
<b>Equipment power</b>	AC output (electrical socket); 100-240 VAC, 16 A, 50-60 Hz.
<b>Charger output</b>	USB-C output 18 W

### EXTRA FEATURES

---

<b>Options</b>	<ul style="list-style-type: none"><li>  7-inch manual <b>control screen</b>.</li><li>  Metal hydraulic <b>air spring</b> for door closure.</li><li>  Invisible <b>wireless charger</b> on the desk.</li><li>  High-capacity load <b>casters</b>. The adjustment of the casters and leveling feet is done from inside the BUBLING.</li><li>  Adjustable <b>facial light</b> up to 500 lux on the user's face.</li><li>  <b>Bubling Fresh Air</b> system, non-adjustable and noise-free.</li><li>  <b>Adjustable height desk</b> system with a range of 730-1200 mm / 28.74x47.24 in.</li></ul>
----------------	---

### SPACE AND INSTALLATION

---

<b>Required space</b>	Depth of the BUBLING: 1006 mm / 39.61 in + 100° door opening. Minimum recommended space for air circulation above and on the sides: 150 mm / 5.91 in.
<b>Installation space</b>	The installation requires 500 mm / 19.69 in of free space around the BUBLING.
<b>Assembly</b>	<b>Assembly time:</b> 1 hour <b>Number of people:</b> 2 people

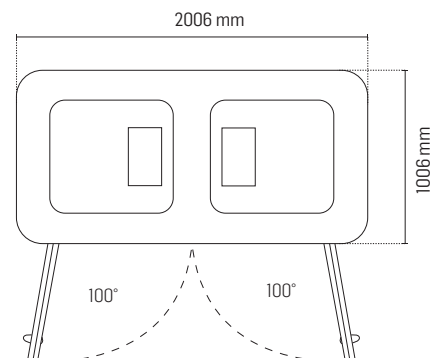

## BUBLING Stwin | STANDARD FURNITURE



**HIGH TABLE**  
730x350x1050 mm  
28,74x13,78x41,34 in



**CLOTHES HANGER**  
1 unit in each space

## BUBLING Stwin | OPTIONAL FURNITURE



**HIGH STOOL**  
400x400x580-780 mm  
15,75x15,75x22,83-30,71 in



**BACKREST**  
570x145x760 mm  
22,44x5,71x29,92 in

## BUBLIING Stwin | STANDARD FEATURES



### CONNECTIVITY

1x presa standard Schuko - 230 V  
1x ingresso USB-C



### DIMMER SWITCH

Intensity regulator for lighting and ventilation.

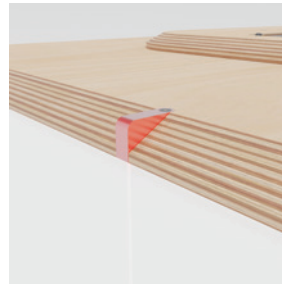

### OCCUPANCY INDICATOR

Tecnologia a sensore LED per esterni.  
2 unità.

## BUBLIING Stwin | OPTIONAL FEATURES



### CASTERS

High load capacity. Adjustment is made from the inside.



### AIR SPRING

Metal hydraulic for door.

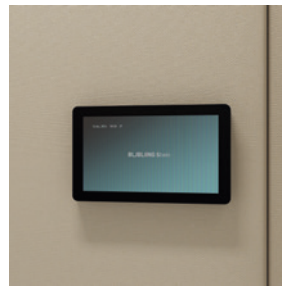

### CONTROL SCREEN

7-inch manual control.



### FACIAL LIGHT

LED lighting 3500 K - 4000 K.  
Up to 500 lux on the user's face.



### WIRELESS CHARGER

Invisible charger on the desk.



### LIFTING TABLE

Height adjustable system:  
730-1200 mm / 28.74x47.24 in.

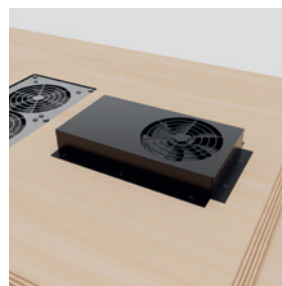

### BUBLIING FRESH AIR

Non-adjustable system.  
Noise-free.



## BUBLING Stwin | FINISHES





### INTERIOR FINISH

 Beige CSE01	 Light Blue CSE38
 Light Gray CSE41	 Navy Blue CSE40
 Charcoal Gray CSE13	 Coral Red CSE24
 Brown Beige CSE02	 Classic Red CSE29
 Tea Green CSE33	 Yellow CSE03
 Olive Green CSE34	 Mustard CSE31

### EXTERIOR COATING

 White RAL 9003 MATE	 Dark Blue RAL 5001 MATE
 Light Gray RAL 9002 MATE	 Light Blue RAL 5014 MATE
 Dark Gray RAL 7039 MATE	 Dark Green RAL 6028 MATE
 Black RAL 9005 MATE	 Light Green RAL 6021 MATE
 Red Beige RAL 3012 MATE	 Beige RAL 1001 MATE

### INTERIOR FLOORING

 Beige 393100
 Brown 327260
 Dark gray 393350
 Light Gray 393300

### TABLETOP

 Plywood with white laminated	 Plywood with anti-fingerprint black laminated	 Plywood with oak laminated
---	---	---

Due to the different configurations of monitors and printers, the appearance of the finishes may vary from the actual finish. To ensure that the chosen finishes meet your expectations, please refer to physical samples or contact a BUBLING representative.

WORK WELL, LIVE BETTER  
WITH **BUBLING** StwIn

[WWW.BUBLING.COM](http://WWW.BUBLING.COM)